

PRINCETON ORNAMENTAL FIBERFENCE PANEL

4' x 8'

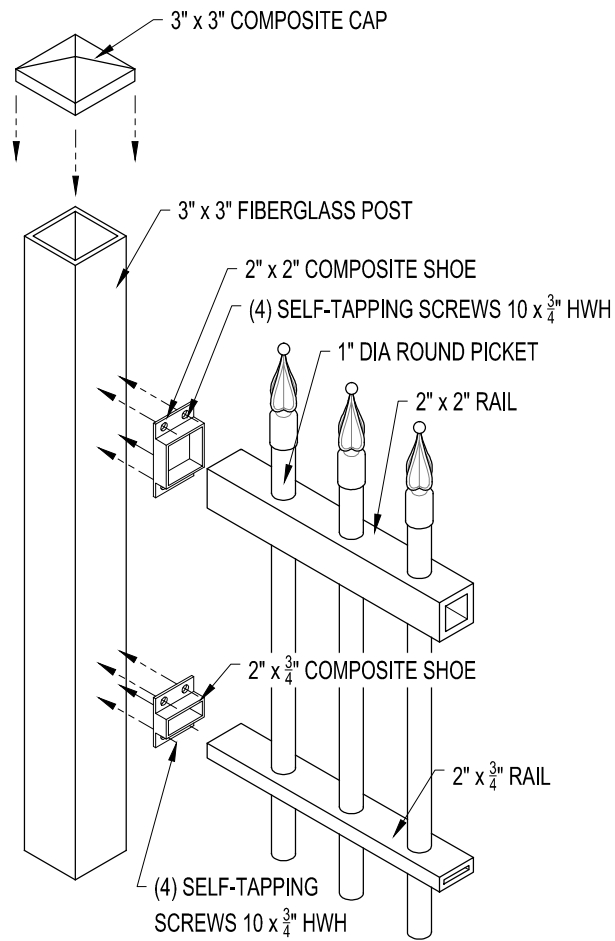

INSTALLATION
03 RAIL TO POST DETAIL

SCALE: NTS

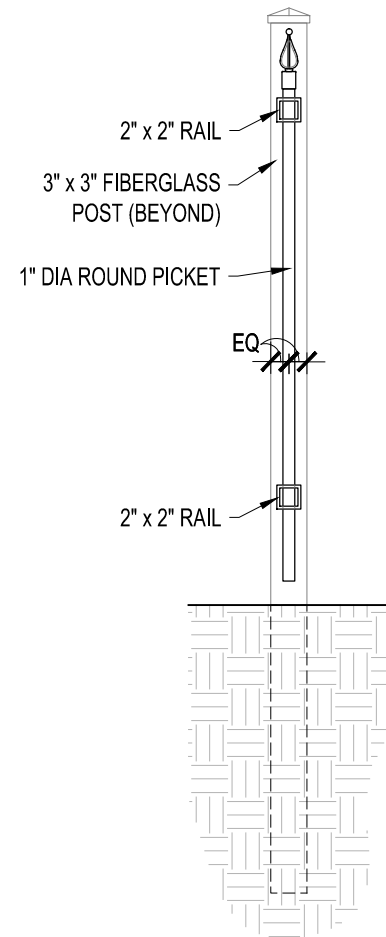

02 FENCE SECTION

Scale: 3/4" = 1'-0"

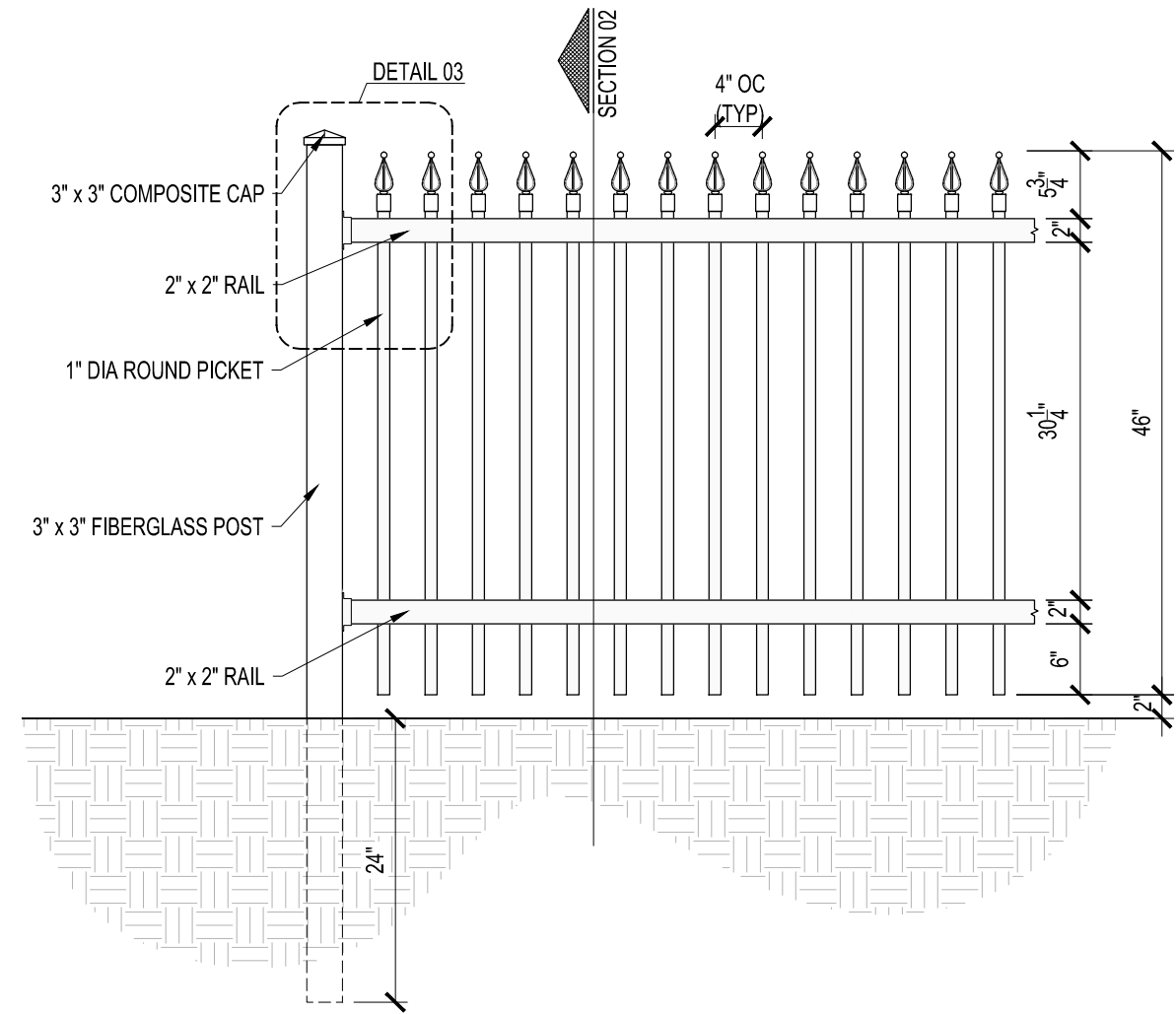

01 FENCE ELEVATION

Scale: 3/4" = 1'-0"



F & F Composite Group, Inc
P.O. Box 247, Keller, Texas 76244
Tel: 817.379.4411 Fax: 817.379.4296
www.fiberfence.com

VIEW:	MULTI	
SCALE:	NTS	
DRAWN BY:	JGS	
CHECKED BY:		
APPROVED BY:		
DATE:	05.02.17	
REV	DATE	DRAFTER

SHEET
1.00

ALL IDEAS, DESIGNS, PLANS AND SPECIFICATIONS REPRESENTED BY THESE DOCUMENTS, ARE OWNED BY F & F COMPOSITE GROUP, INC. AND ARE THE PROPERTY OF THIS OFFICE AND WERE CREATED FOR USE ON AND IN CONNECTION WITH THE SPECIFIED PROJECT. NONE OF THE IDEAS, DESIGNS, PLANS OR SPECIFICATIONS SHALL BE USED BY OR DISCLOSED TO ANY PERSON, FIRM OR COMPANY FOR ANY PURPOSE WITHOUT WRITTEN PERMISSION OF F & F COMPOSITE GROUP, INC.

WRITTEN DIMENSIONS SHALL TAKE PRECEDENCE OVER SCALED DIMENSIONS. CONTRACTORS SHALL BE RESPONSIBLE FOR AND FIELD VERIFY ALL DIMENSIONS AND SITE CONDITIONS. IMMEDIATE NOTIFICATION SHALL BE PROVIDED TO F & F COMPOSITE GROUP, INC. UPON DISCOVERY OF ANY VARIATIONS FROM THE DIMENSIONS AND CONDITIONS DEPICTED BY THESE DRAWINGS. SHOP DRAWINGS SHALL BE SUBMITTED TO THIS OFFICE FOR APPROVAL PRIOR TO PROCEEDING WITH FABRICATION.